

AutoSave Off | practical (2) - Protected View - Sa | You are viewing Faiza Arif's screen | View Options | Faiza arif FA | Share | Comments

File Home Insert Draw Design Transitions Animations Slide Show Review View Help

1 To study effects of Ach at different doses and drug antagonism of Ach and atropine on rabbit 's ileum

2 AFFIDAVIT

3

4

5 Tissue organ bath

6

7 Procedure

To study effects of Ach at different doses and drug antagonism of Ach and atropine on rabbit 's ileum

<dr.Faiza arif>

Unmute | Start Video | Participants 41 | Chat | Share Screen | Record | Reactions | Chat | From Sveda to

- 1 To study effects of Ach at different doses and drug antagonism of Ach and atropine on rabbit's ileum
- 2 APPARATUS
 - Tissue bath with optimal temp
 - kymograph
 - oxygen cylinder
 - dissecting instruments
 - tyrode's solution
- 3
- 4
- 5 Tissue organ bath
- 6
- 7 Procedure

APPARATUS

- ▶ Tissue bath with optimal temp
- ▶ kymograph
- ▶ oxygen cylinder
- ▶ dissecting instruments
- ▶ tyrode's solution

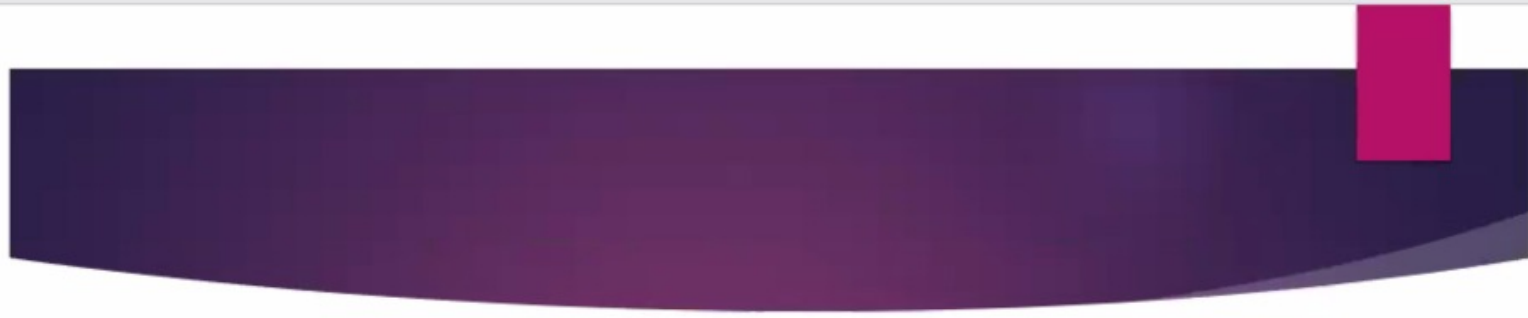
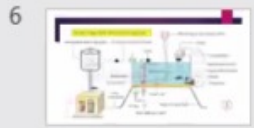
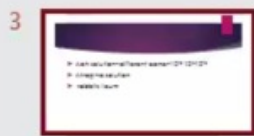
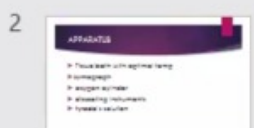
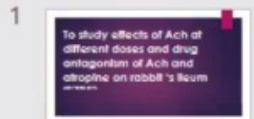

- ▶ Ach solution <different conc> 10^{-5} 10^{-4} 10^{-3}
- ▶ Atropine solution
- ▶ rabbits ileum

1 To study effects of Ach at different doses and drug antagonism of Ach and atropine on rabbit's ileum

2 APPARATUS
• You'll need an optimal lamp
• oxygen source
• dissecting instruments
• tissue retractor

3
• 100 ml normal saline water (37°C) bath
• 100 ml saline
• Rabbit ileum



4 Tissue organ bath



5 Procedure
1) Place 1 x 1 cm intestine out about 5 cm glass & bath
2) Tissue is placed through each end of the clip
3) Connect one end of the oxygen tube and 10 mm tube
4) Place bath contains the organ and tie to the bath
5) Place the normal saline in glass
6) Place 5 ml of bath and record contraction to glass



This Photo by Unknown Author is licensed under CC BY-SA

1 To study effects of Ach at different doses and drug antagonism of Ach and atropine on rabbit's ileum

2 APPARATUS
• You have an optimal temp
• oxygen source
• measuring instrument
• tissue reaction

3 • can be used to study various drugs
• drug reaction
• rabbit ileum



4 Tissue organ bath

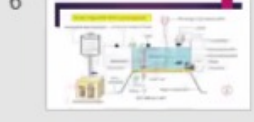

5 Procedure
1) Place 1-2 gm of tissue in a glass or metal bath
2) Place a glass plate through each end of the bath
3) Place one end of the oxygen tube and the other end of the liquid bath in the bath and tie to the bath
4) Place the bath in the organ bath
5) Place 1-2 ml of bath and record contraction to 10 sec

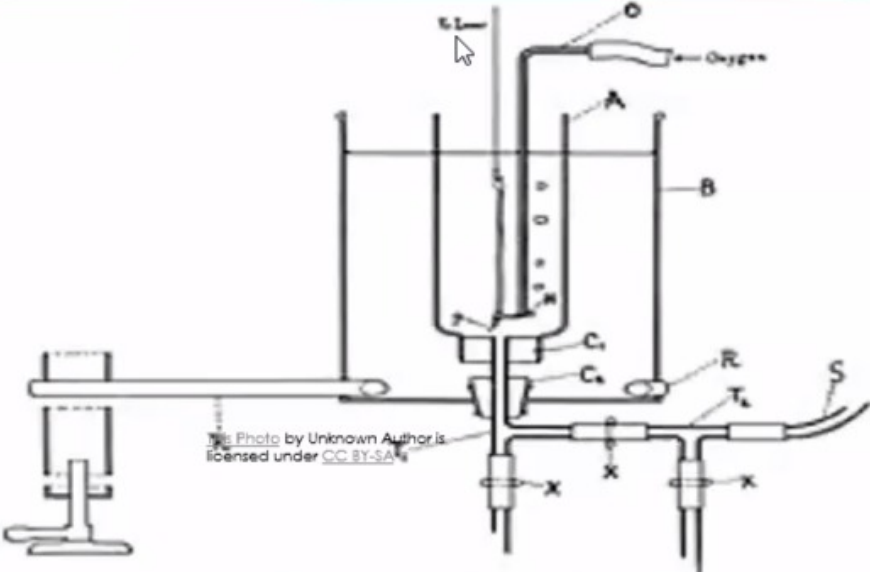

Tissue organ bath

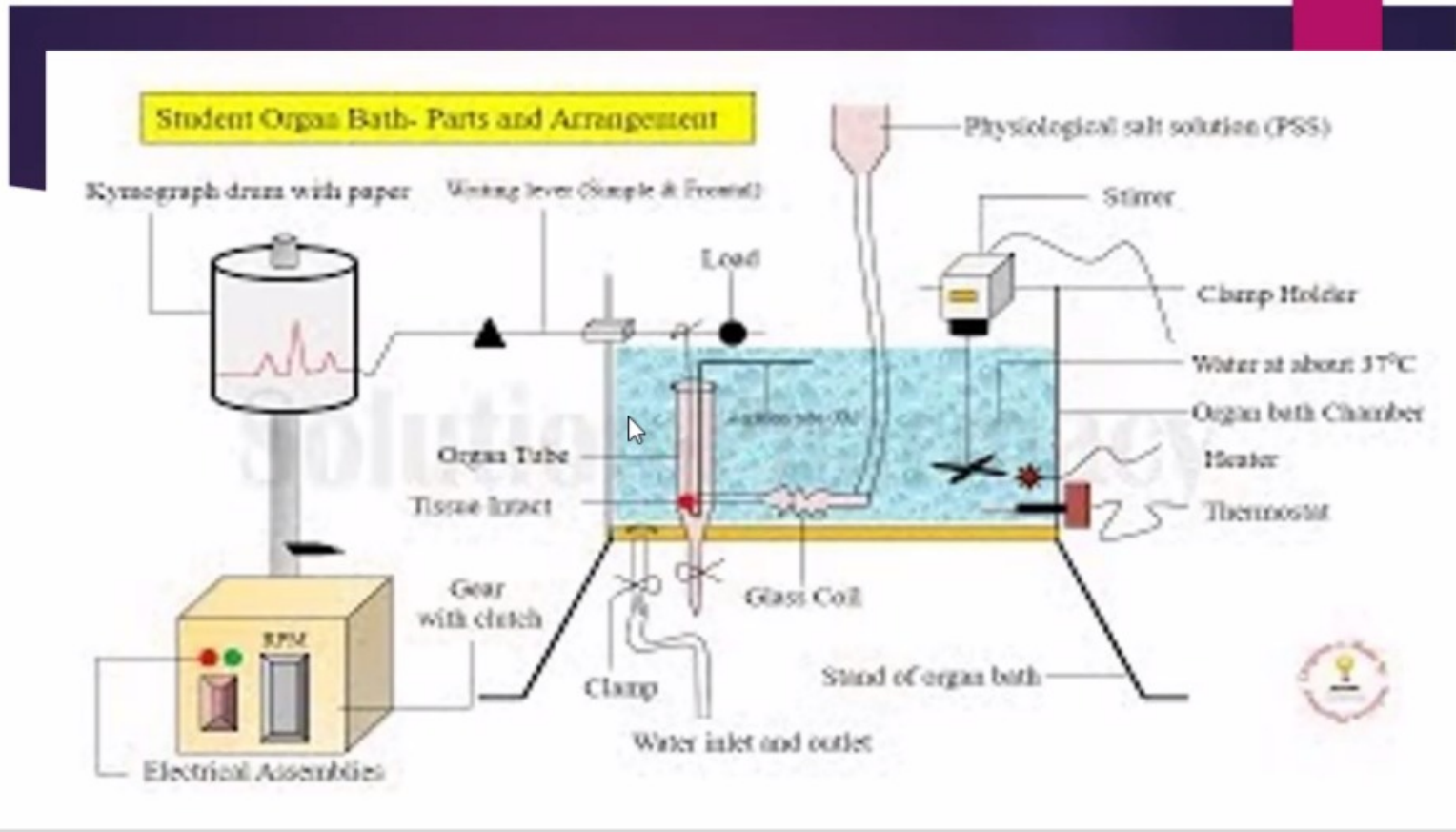

Diagrammatic Representation of Closed Circuit Tissue Organ Bath for Isolated Organ

- 1 To study effects of Ach at different doses and drug antagonism of Ach and atropine on rabbit's ileum
- 2 APPARATUS
 - You have to prepare lamp
 - Kymograph
 - Organ chamber
 - Heating instrument
 - Tissue bath
- 3
- 4
- 5
- 6
- 7 Procedure
 - Place 1-2 inch intestine in about 5cm glass & leave it
 - Press it gently through both ends of the stop
 - Insert one end of the organ tube and fix it to the bath
 - Insert both ends of the organ and tie to the bath
 - Place the nerve leading to it
 - Place 5 ml of bath and neural secretions to it

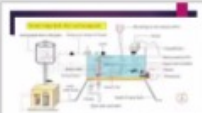

- 1 To study effects of Ach at different doses and drug antagonism of Ach and atropine on rabbit 's ileum
- 2 APPARATUS
 - Tissue bath with oxygen lamp
 - Kymograph
 - Oxygen reservoir
 - Drawing instrument
 - Tissue solution
- 3
 - Dissection of rabbit ileum (20-30cm)
 - Ligature solution
 - Rabbit ileum
- 4 
- 5 Tissue organ bath 
- 6 
- 7 Procedure
 - 1) Rabbit 's ileum is dissected out about 2cm piece is taken out
 - 2) Thread is passed through both ends of the strip
 - 3) Mount one end of the oxygen tube and it remains fixed in tissue bath whereas the other end tied to the lever which moves on the kymograph
 - 4) Record the normal reading for 30sec
 - 5) Add 0.1 ml of ach and record contractions for 30sec

Procedure

- ▶ Rabbit 's ileum is dissected out about 2cm piece is taken out
- ▶ Thread is passed through both ends of the strip
- ▶ Mount one end of the oxygen tube and it remains fixed in tissue bath whereas the other end tied to the lever which moves on the kymograph
- ▶ Record the normal reading for 30sec
- ▶ Add 0.1 ml of ach and record contractions for 30sec

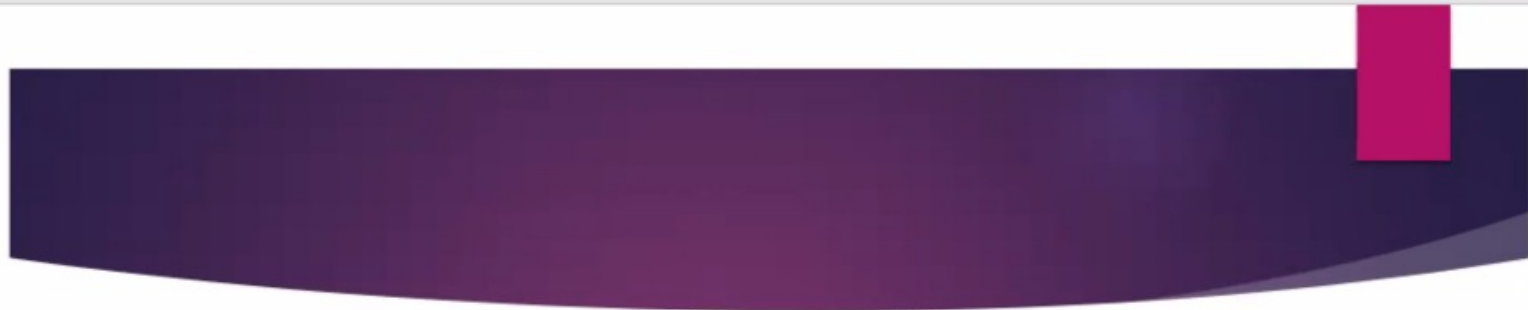
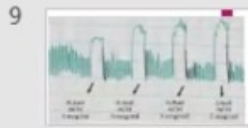

- ▶ Stop kymograph and wash the tissue with tyrode's solution 3 times
- ▶ Again take the normal reading for 30sec
- ▶ Repeat the same procedure with successively increasing doses of different concentrations of Ach until ceiling effect is observed

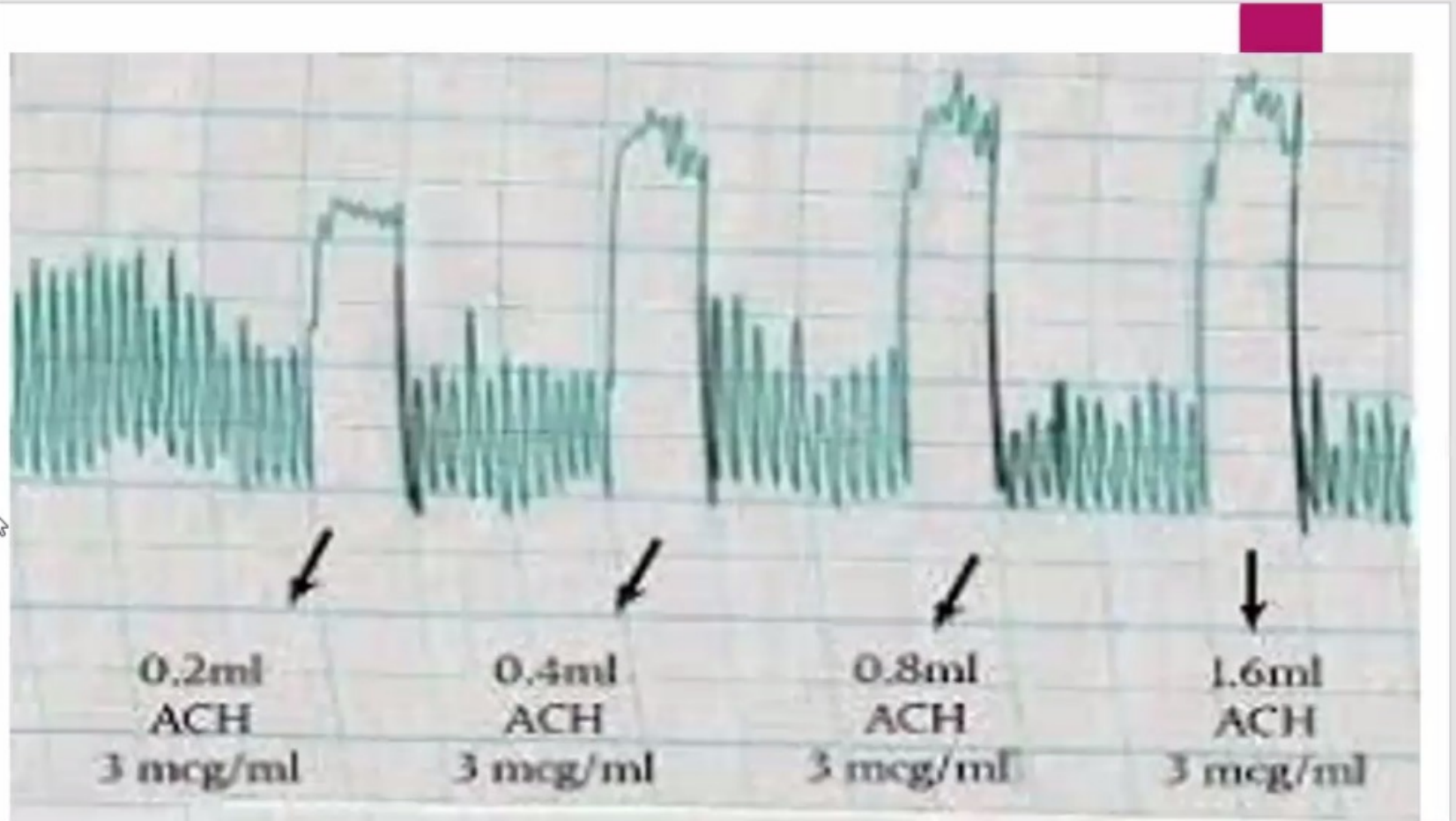
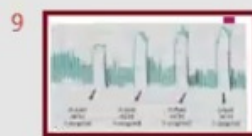

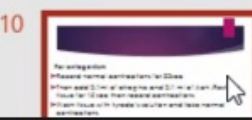
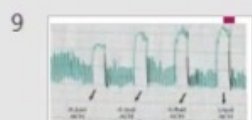

For antagonism

- ▶ Record normal contractions for 30sec
- ▶ Then add 0.1 ml of atropine and 0.1 ml of Ach .Rest the tissue for 15 sec then record contractions
- ▶ Wash tissue with tyrode's solution and take normal contractions
- ▶ Again add 0 .1 ml of atropine with successively increasing doses of Ach until maximum response is obtained ,

- 7
- 8
- 9
- 10
- 11
- 12
- 13

For antagonism

- ▶ In the presence of atropine contionus increasing dose of ACH shows antagonism..
- ▶ Graph would be shifted to right.

Antagonist drug (Atropin

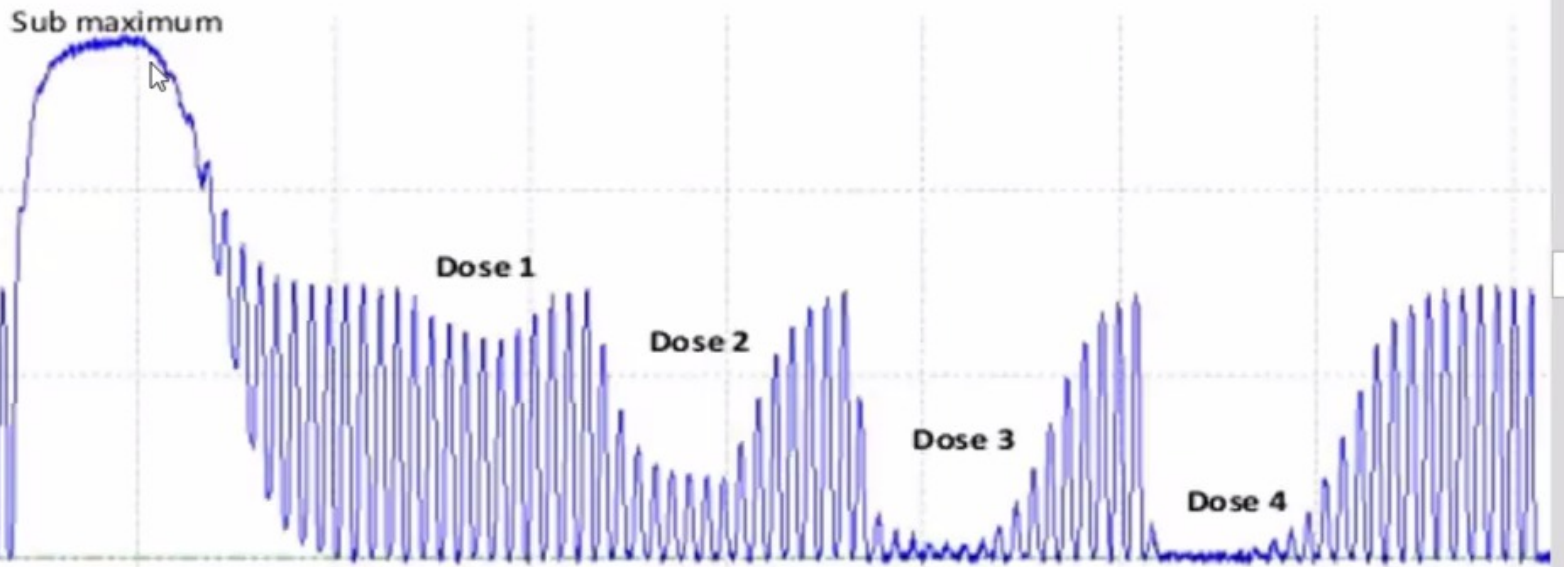

- 7
- 8
- 9
- 10
- 11
- 12
- 13

Precautions

- ▶ Temperature of tissue bath should be maintained throughout the experiment at 37°C
- ▶ There should be continuous oxygen supply
- ▶ Lever should be horizontal
- ▶ Mark the tissue bath for constant levels of solution
- ▶ Always record normal contractions before adding next Ach concentrations

Composition of Tyrode solution

1. Nacl 8g
2. Kcl 0.2g
3. $CaCl_2$ 0.2g
4. $MgCl_2$ 0.1g
5. NaH_2PO_4 0.05g
6. $NaHCO_3$ 1g
7. Glucose 1g
8. Distill water 1L

ASSIGNMENT NO 2

- ▶ QNO.1:What are benefits of making stock solution?
- ▶ Qno.2:name three groups of drugs along with example have inhibitory effects on intestine?
- ▶ Qno.3:draw the diapghram of tissue organ bath along with kymograph?

From Shahryaar Ahmad 117 to Everyone

F18-117